



New Advantage and New Contour Electro Screens



Get ready to redefine the term *standard*. With valued customers in mind, Da-Lite has upgraded the standard features included on the bestselling Advantage® and Contour® projection screen lines. As part of Da-Lite's lasting legacy of innovation, these improvements represent an ongoing promise to provide the highest levels of service and the best products available whenever and wherever projection screens are needed.

New Features



Standard Silent Drive System:

- An enhanced drive mechanism to keep your screen whisper quiet.
- Internal vibration isolators enhance quiet operation
 - Silent Drive Motor on screens 10' x 10' and smaller

INDUSTRY FIRST

Standard LVC: Integrated low voltage control to keep your screen operation flexible.

- Dry contact closures included for third party control
- Easy to add Da-Lite's wireless control options

Slim-Tab: A lower profile, stronger tab design to keep your screen perfectly tensioned.

- Tab size optimized for strength and screen flatness
- Redesigned geometry to eliminate tab impressions

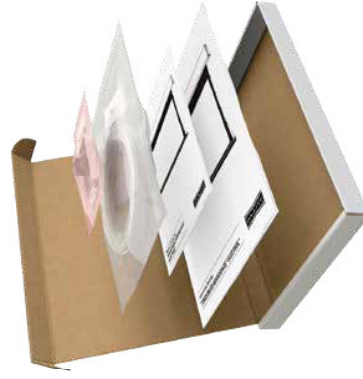

Smooth Roll Technology: A patent pending roller technology to keep your screen perfectly flat.

- Completely flat screen surface without roller impressions

INDUSTRY FIRST

5 YEAR WARRANTY

Support: A comprehensive five year warranty to keep you confident in your purchase.

- Warranty includes entire product; case, screen surface, tabs and motor

INDUSTRY LEADING

Simple Installation: A new Installation Kit and user-friendly packaging to keep you on schedule.

- Everything needed for installation in one convenient package
- New Owner's Manual and improved Instructions

Products

When ordering any of these screen models, simply add the suffix LS for screens 10' x 10' and smaller. Add the suffix L for screens larger than 10' x 10' in size. The improvements and additional features added to these screen models will not affect any of the published standard dimensions listed by Da-Lite.

Advantage screen models can be ordered as a complete unit or the case can be ordered separately from the fabric and roller assembly. Ordering a case separately prevents damage to the screen fabric during the construction of a building. When construction is completed, the fabric and roller assembly can then be ordered from Da-Lite to finish the installation.

When ordering an Advantage screen model in two parts, simply add the suffix BLS for the case and FLS for the fabric and roller assembly for screens 10' x 10' and smaller. Add the suffix BL for the case and FL for the fabric and roller assembly for screens larger than 10' x 10' in size.

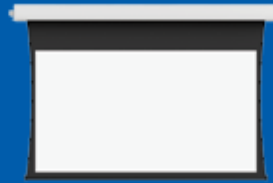

Tensioned Advantage Electrol

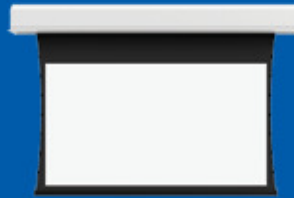

Tensioned Large Advantage Electrol

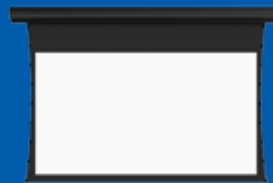

Tensioned Contour Electrol

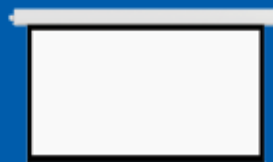

Advantage Electrol

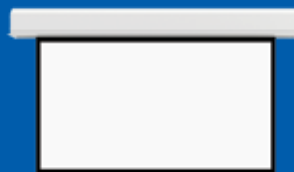

Large Advantage Electrol

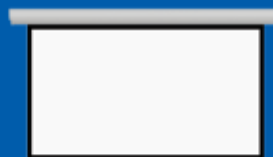

Contour Electrol

Advantage Electrol[®] Installer Friendly Features

Versatile Installation

- Case can be ordered separately from the fabric and roller
- Prevents fabric damage during construction



Versatile Case Design

- UL plenum rated for air handling spaces
- Integrated trim flange for a clean, finished look
- Adjustable mounting brackets

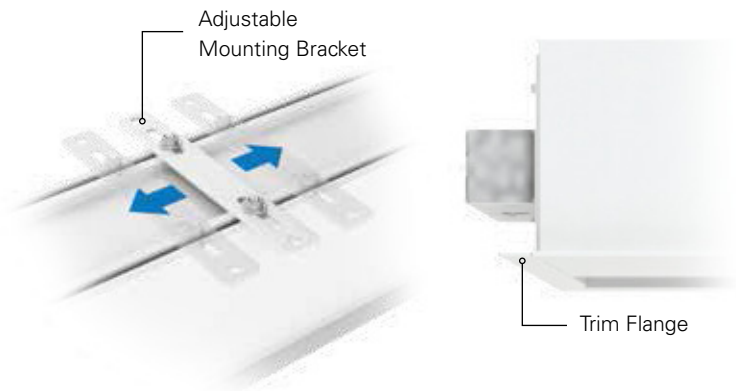

Versatile to Upgrade

- Future fabric upgrades
- Order larger case for future format upgrades
- Adjustable internal brackets
- Quick Connect power and low voltage interface

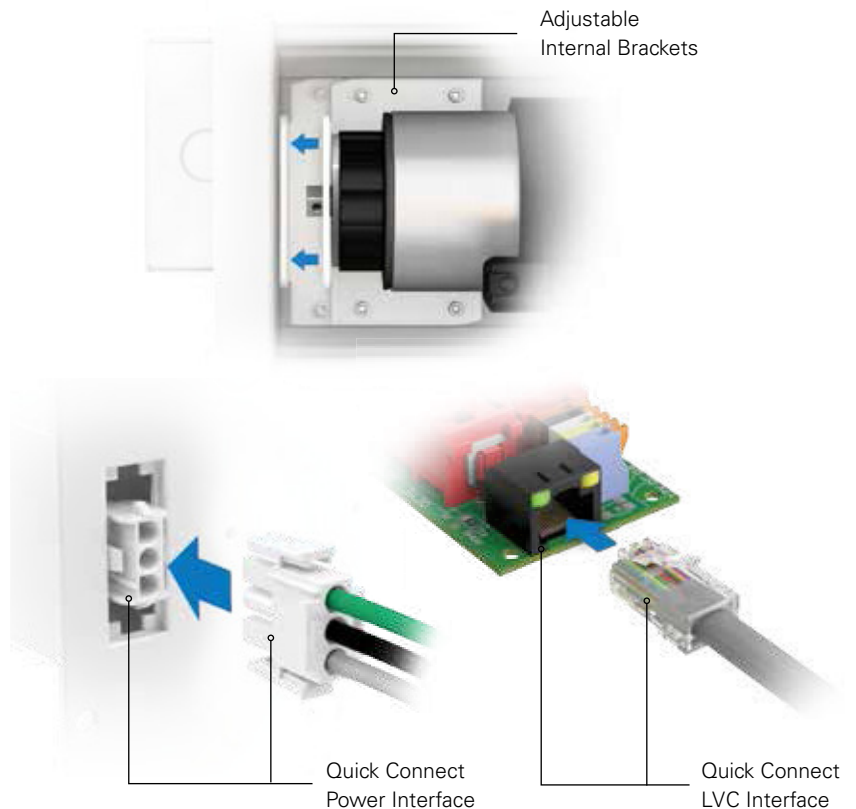

A Milestone AV Technologies Brand
3100 North Detroit Street
Post Office Box 137
Warsaw, Indiana 46581-0137
P: 574.267.8101 or 800.622.3737
F: 574.267.7804 or 877.325.4832
E: info@da-lite.com
www.da-lite.com
DL-0121 01.13

© 2013 Milestone AV Technologies LLC. Printed in U.S.A.

 Printed on Recycled Paper